

DEMAND CONTROL OPTION PCB

(Optional parts)

MODEL NAME :

UTY-XCZZ1

UTY-XCZZ2

1. FEATURE

■ MODEL

UTY-XCZZ1

UTY-XCZZ2

■ FEATURE

The split air conditioner compatible with Demand control option PCB which saves electricity automatically at the peak of demand.

● Demand Control



Restrict the operation of air conditioner base on the demand of energy provider in order to cut the peak load.

- Demand response is supported. (Option)

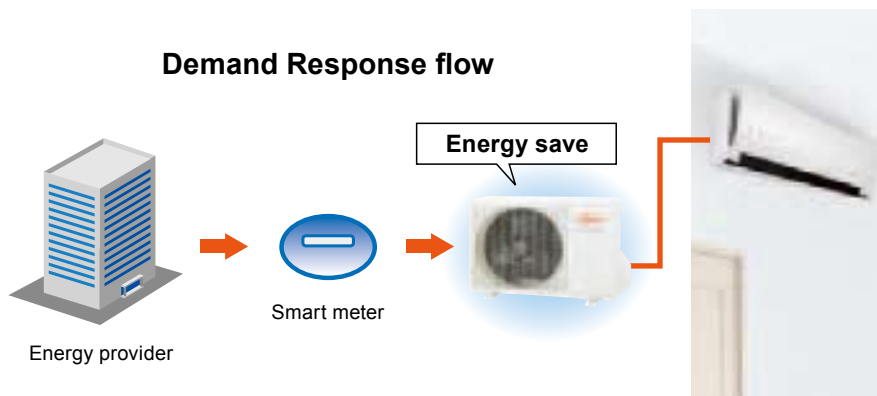

The above example figure: Compact wall mounted type air conditioner (ASTG14LUCB)

2. SPECIFICATIONS

■ DEMAND CONTROL OPTION PCB

Model name			UTY-XCZZ1	UTY-XCZZ2
Power Supply		Connecting with Control box of outdoor unit		
Dimension (H × W × D)	Net	mm	20 × 43 × 59	23 × 59 × 103
	Gross		47 × 124 × 106	
Weight	Net	kg	0.02	0.055
	Gross		0.1	0.15
Usage temperature range		It is based on outdoor unit to connect.		
Connector cable length (PCB to Outdoor unit)		mm	230	140

■ CABLE SPECIFICATIONS

Between Smart meter to Demand control option PCB(Field supply)

Use cable conformed to AS/NZS 5000.2.

Type	Double insulated
Size	0.5 - 1.5 mm ²
Maximum wiring length	30m

3. PRECAUTION

This product is designed to be compatible with Air Conditioning Demand Response program.

To utilize the function, Demand Response (DR) adapter kit that interconnects your air conditioner and Demand Response Enabling Device (DRED) needs to be installed in your air conditioning system, and you need a separate arrangement.

WARNING

 This unit contains no user-serviceable parts. Always consult authorized service personnel for repairing, installation, and relocation of this product. Improper installation or handling will cause leakage, electric shock, or fire.

DR mode	Description of operation in this mode
DR mode 1	Compressor off.
DR mode 2	The air conditioner continues to cool or heat during the Demand Response event, but the electrical energy consumed by the air conditioner in a half hour period is not more than 50% of the total electrical energy that would be consumed if operating at the rated capacity in a half hour period.
DR mode 3	The air conditioner continues to cool or heat during the Demand Response event, but the electrical energy consumed by the air conditioner in a half hour period is not more than 75% of the total electrical energy that would be consumed if operating at the rated capacity in a half hour period.

When the unit goes into a DR mode, it performs moderate operation though the cooling or heating effect may be reduced. You cannot override this function with changing the temperature setting by using the remote controller or other actions unless the unit finishes the function.

Notes: Stopping the operation of the air conditioner by using the remote controller or by OFF timer are valid in DR mode. If the timer operation is interfered by an interruption of power supply such as a blackout and the power supply is resumed, no indication of the DR mode is performed. During the DR mode, no indication of "filter sign" is performed. Powerful operation is performed within the operable range of the DR mode.

When the unit finishes the function, it will perform the operation that was previously performed before entering the DR mode.

When this air conditioner is connected to a DRED, and you have operational issues, contact your electricity supplier first to check whether they are activating any of the DR mode described above.

If the air conditioner is under demand controlling, consult on the issues with your electricity supplier.

If they are not demand controlling the air conditioner, refer to your warranty card for the contact details of Fujitsu General (AUST.) PTY LIMITED or visit our website : www.fujitsugeneral.com.au

4. PARTS NAME

■ MODEL: UTY-XCZZ1

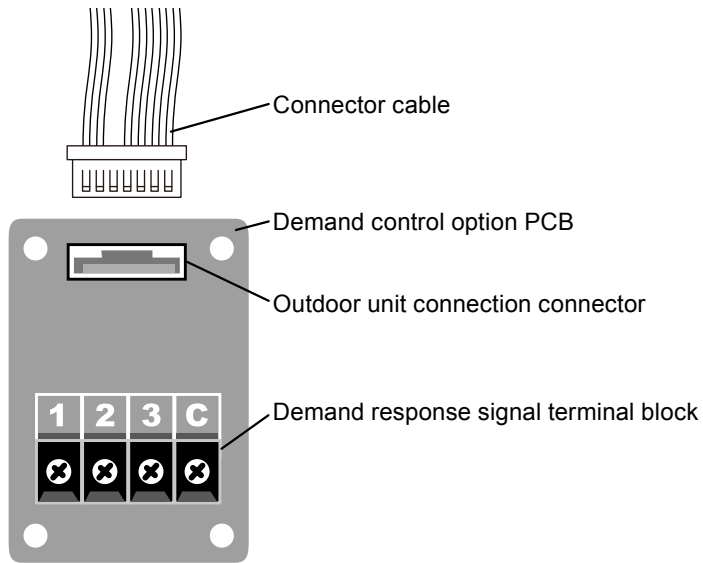

DEMAND CONTROL
OPTION PCB

DEMAND CONTROL
OPTION PCB

■ MODEL: UTY-XCZZ2

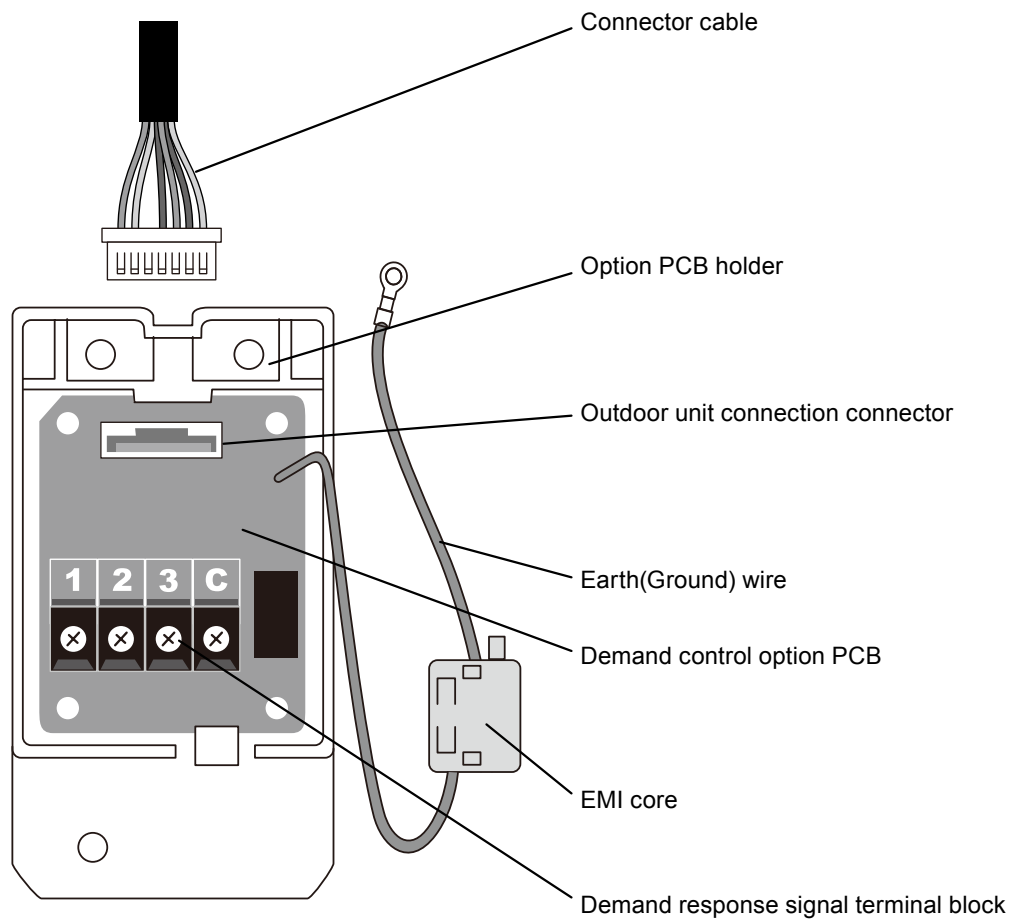

5. ELECTRICAL WIRING

DEMAND CONTROL
OPTION PCB

DEMAND CONTROL
OPTION PCB

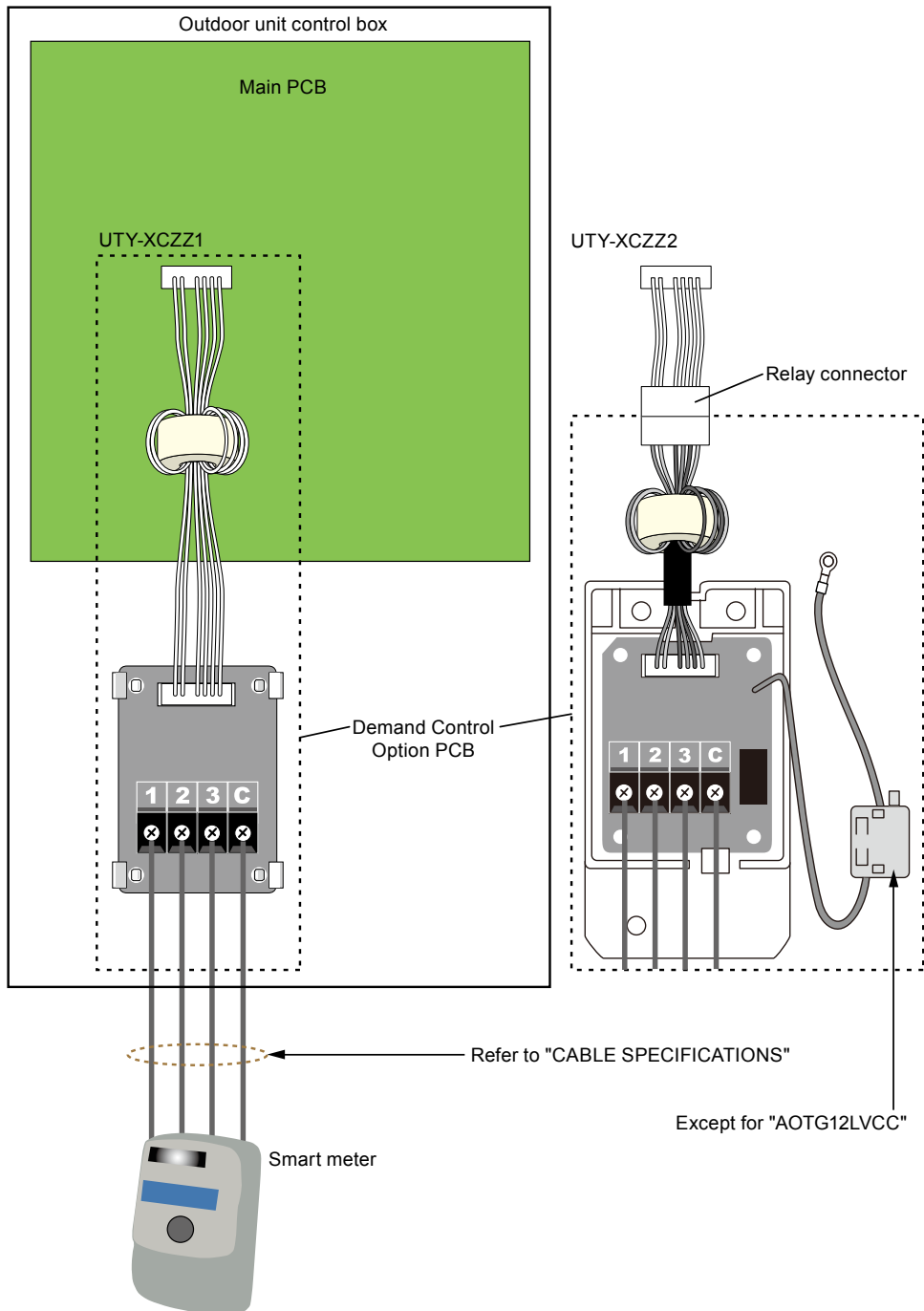

*1: Use cable conformed to AS/NZS 5000.2.
Circuit and signal parameter conformed to AS/NZS 4755.3.1.

Caution: Please do not connect two or more "Demand control option PCB" to one Smart meter.

Connection table by mode

Board-side terminal		1	2	3	C
DRED-side terminal		DRM1	DRM2	DRM3	COMMON
Response mode	DRM1	○			○
	DRM1 DRM2	○	○		○
	DRM1 DRM3	○		○	○
	DRM1 DRM2 DRM3	○	○	○	○

The response mode will vary depending on the outdoor unit.
The response mode is given in the documents that come with the outdoor unit.

6. INDICATOR OF INDOOR UNIT

When your electricity supplier activates one of the following 3 DR modes, the air conditioner switches over to the appropriate operation, and the OPERATION indicator (green) on the indoor unit blinks to inform you it has been entered to the DR mode.

OPERATION indicator (indoor unit)



Blinking pattern and the interval are as follows:

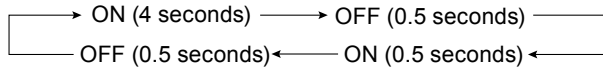







The indicator will keep blinking until the unit finishes the function.

Notes:



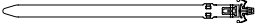

- Shape, number, and the arrangement of the indicators are unit-dependent.
- Some indoor units may not have the indicators unless the optional control panel or IR receiver kit has been installed.

7. ACCESSORY PARTS

■ MODEL: UTY-XCZZ1

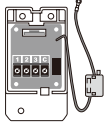
Name and shape	Q'ty	Summary
Instruction manual 	1	
Demand control option PCB 	1	Cooling and heating operations of air conditioners are limited by the external input.
Connector cable 	1	For demand control option PCB connection
Spacer 	4	For fixing the demand control option PCB
Cable tie with clip 	1	For fixing the signal cable (for connecting to the demand response signal)
Cable tie 	1	For fixing the connector cable
One-touch bush 	1	For attaching the signal cable (for connecting to the demand response signal)

■ MODEL: UTY-XCZZ2

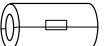
Name and shape	Q'ty	Summary
Instruction manual 	1	
Demand control option PCB Option PCB holder 	1	Cooling and heating operations of air conditioners are limited by the external input.
Connector cable 	1	For demand control option PCB connection
Cable tie with clip 	1	For fixing the signal cable (for connecting to the demand response signal)
Cable tie 	2	For how to use it, refer to the demand response instruction manual for each outdoor unit. Required number of cable tie varies according to the outdoor unit.
Tapping screw 	1	For attaching the option PCB holder
EMI core 	1	Attached to the signal transmission cable